

Product Dimensions

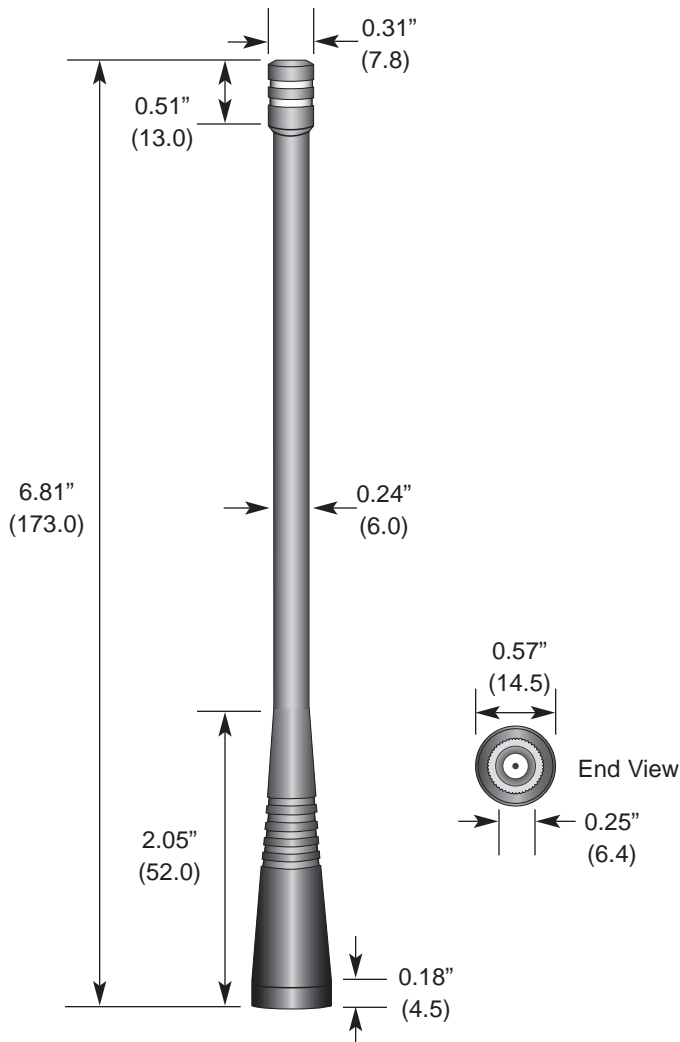

Description



CW Series 1/4-wave antennas deliver outstanding performance in a rugged and cosmetically attractive package. These antennas feature an FCC Part 15 compliant RP-SMA connector. This simplifies packaging and shipment, allowing for easy field replacement while complying with FCC requirements. A wide variety of matching connectors allows for numerous mounting options.

Features

- Low cost
- Excellent performance
- Omni-directional pattern
- Wide bandwidth
- Very low VSWR
- Fully weatherized
- Flexible main shaft
- Rugged & damage-resistant
- Part 15 compliant RP-SMA connector
- Use with plastic* or metal enclosures

* Requires proximity ground plane

Electrical Specifications

- Center Freq. 433MHz
- Bandwidth 80MHz
- Wavelength 1/4-wave
- VSWR <1.9 typ. at center
- Impedance 50 ohms
- Connector RP-SMA

Electrical specifications and plots measured on 4.00" x 4.00" reference ground plane

Ordering Information

- ANT-433-CW-QW

VSWR Graph

